

Varenummer: 392207500753636  
 Beskrivelse: Snekkegear med skridnav  
 W75 L2-UFC-7-P90B14

## Mål

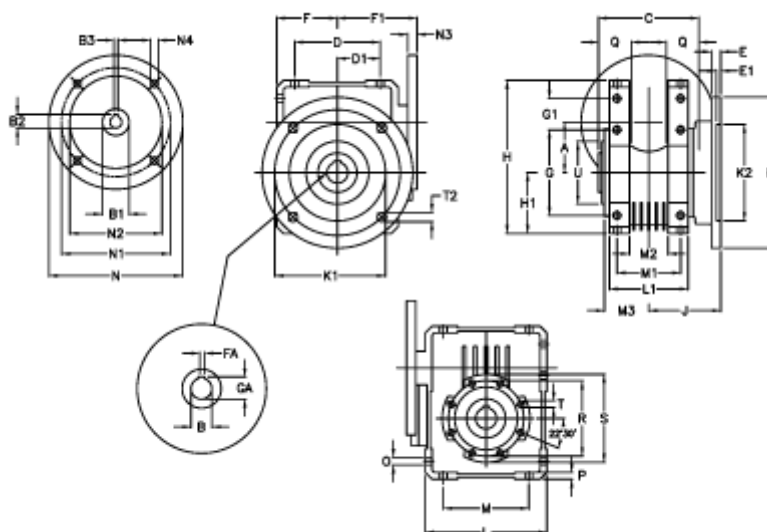

A = 75.00	E = 12	H = 220.5	M = 126	N4 = 8,5	U = 90
B = 30	E1 = 5	H1 = 87.0	M1 = 82	O = 10.5	
B1 E7 = 24	F = 87	J = 85.0	M2 = 44	P = 9	
B2 = 27.3	F1 = 112	K = 200	M3 = 58.5	Q = 40	
B3 H9 = 8	FA = 8	K1 = 165	N = 140	R = 110	
C = 127	G = 126	K2 = 130	N1 = 115	S = 125	
D = 109.5	G1 = 46.5	L = 174	N2 = 95	T = M8x14	
D1 = 46.5	GA = 33.3	L1 = 104	N3 = 7,5	T2 = 12.5	